



**KTBIN® THE MULTI PURPOSE
BULK CONTAINER SYSTEM**

KTBIN®



Features

- *The bin that grows with your needs from single up to triple height*
- *Space savings of up to 63%*
- *Comprehensive solutions for the whole supply chain*
- *Unique removable walls*
- *Quick and easy assembly*
- *Patented locking design*
- *Hygienic smooth surfaces*
- *Available with solid or perforated wall sections*
- *Four-way forklift entry*
- *Removable walls provide easy access for ergonomically correct loading and unloading*



KITBIN® THE MULTI PURPOSE BULK CONTAINER SYSTEM



One Modular Product For Many Kinds of Solutions

The *KitBin*® is a uniquely designed system offering considerable flexibility.

The system is comprised of a pallet base and four independent sides, fitted together to create a strong and durable container whilst offering space savings when not in use.

- The unique interlock mechanism is the key to the *KitBin*'s flexibility. It allows each side panel to be locked into position around the pallet base giving added strength. This enables sidewalls to be built up to three high giving one container a range of heights from 715mm to 1845mm.
- The base can also be used independently as a standard pallet when the sidewalls are not required.
- Units are moulded in tough structural foam and have been designed to withstand impact, resulting in vastly improved product protection and reduced product damage during transit.
- The true modular construction of the system also means simpler and easier repairs.



Easy and Simple Assembly

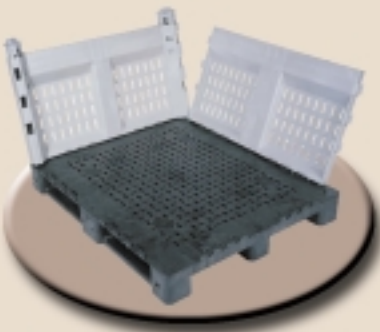

- 1 Insert side wall panels into pallet base.

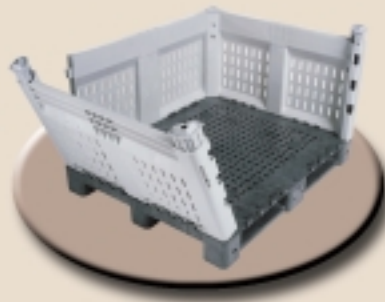

- 2 Align sidewalls so that interlocking mechanism can be engaged.



- 3 Repeat steps 1 and 2 for other walls.

Unique design patented lock



1



2



3

The patented design allows any of the walls to be completely detached from the pallet base so that the container can be filled from the front by leaving one wall detached

Walk-in system

Any wall can be easily removed and the system becomes a Walk-in system.

- Easy access
- Ergonomically Correct



Four way forklift entry



KITBIN® THE MULTI PURPOSE BULK CONTAINER SYSTEM



Space saving

Four disassembled containers fit into one *KitBin*® with the pallet bases nested on top. Five *KitBins* can therefore fit into the same footprint as one. It means savings of up to 63% storage area space.

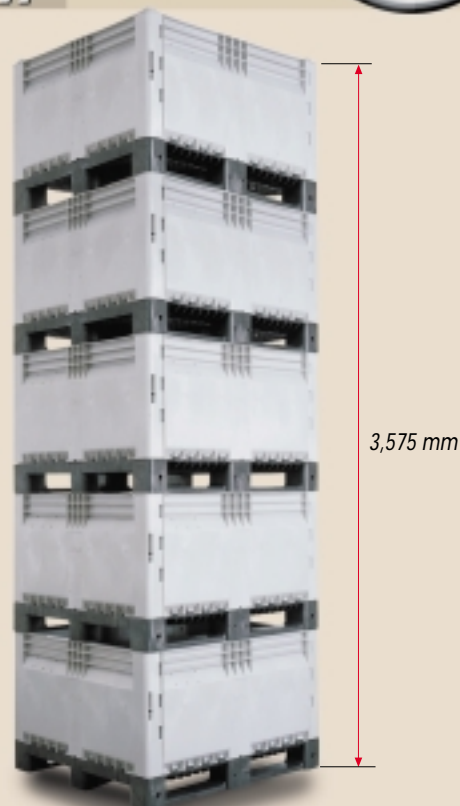
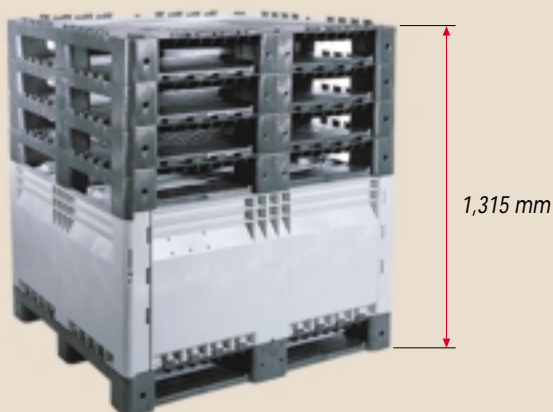

Sea transportation

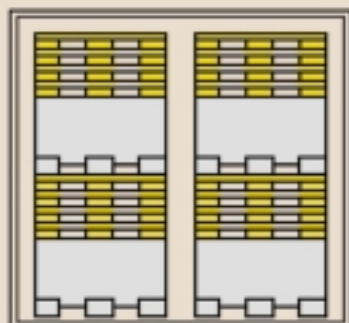

Folded KitBins in Containers (units)			
	20'	40'	40' HC
Single Height Kitbin	80	176	216
Double Height Kitbin	45	105	149
Triple Height Kitbin	45	95	105

Road transportation

	Size m			Volume m ³	Single Height		Double Height		Triple Height	
	L	W	H		Folded	Erected	Folded	Erected	Folded	Erected
Truck	9.45	2.5	2.8	62	180	54	120	36	90	18
Semi Trailer	13.4	2.5	2.8	94	260	78	180	52	130	26
Full Trailer	A+B			120	300	120	220	60	150	30
Porter only (A)	7.32	2.5	2.9		140	56	100	28	70	14
Trailer only (B)	8.13	2.5	3		160	64	120	32	80	16



Customised products

The *KitBin®* system - customised for your needs



Mega KitBin®

L	W	H
mm	mm	mm
1600	1200	715



Mini KitBin®

L	W	H
mm	mm	mm
1200	1000	505



Euro KitBin®

L	W	H
mm	mm	mm
1200	800	715

Optional products

Many more options are waiting for you. Just tell us what you require and our product engineers will find the best solution for you.



KitBin® with Lid



KitBin® with Wheels



KitBin® with Door

Modular products

Variable height options

The inherent internal strength of the *KitBin®* and its locking mechanism means the sidewalls can be built up either two or three units high on one pallet base, giving one container a range of heights from 715mm to 1845mm.

Ideal for bulky items or where transport / storage space is at a premium, *KitBin®* is also available with a special wall option which allows side access to the contents within the container.





Maximum loading 600kg per unit.



KITBIN® THE MULTI PURPOSE BULK CONTAINER SYSTEM



Technical data

	KitBin® Single height	KitBin® Double height	KitBin® Triple height
External Dimensions (LxWxH) mm	1200x1000x715	1200x1000x1280	1200x1000x1845
Internal Dimensions (LxWxH) mm	1116x916x565	1116x916x1130	1116x916x1695
Volume (liter)	617	1234	1851
Tare Weight (Kg)	39	59	79
Max Load (Kg)	600	600	600
Stack Load (Kg)	3000	1800	1200
Material	HDPE Structural Foam		
Temperature Range	-40°C up to +60°C		
Type*	Perforated/Solid/Both		
Standard Colour	Grey 		
Available Colours**	Yellow  Green  Brown  Blue 		

*Type options-solid pallet with perforated walls or solid walls with perforated pallet

**Those colours available for a minimum order of 1000 KitBin® units

KitBin® solid Triple height



KitBin® solid Double height



KitBin® solid Single height

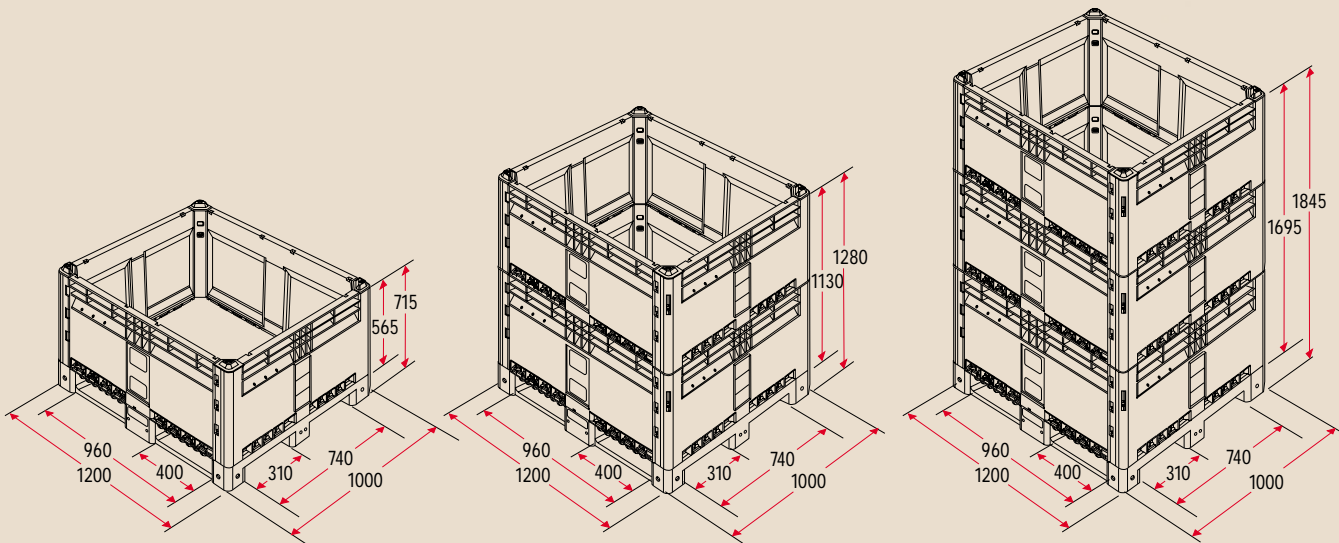

KTBIN®

Company Profile

Dolav Plastic Products was established in 1976 in southern Israel. The company specialises in large structural foam injection mouldings. Dolav Plastic Products utilises advanced technology and equipment to manufacture heavy-duty box pallets that are unique. They are easy to clean, resistant to corrosion, durable and lightweight.

Our boxes are UV resistant, and can withstand a wide range of temperatures. They are manufactured in either solid or perforated, in various sizes and colours, and can be safely stacked 6 high.

DOLAV box pallets are used in all kinds of light and heavy industries - agriculture, food, fishing, recycling industry, chemical, textile, pharmaceutical, etc.



Kibbutz Dvir M.P. HaNegev 85330

Tel: 972 - 8 - 9111700

Fax: 972 - 8 - 9918710

E-mail: dolav@dolav.com

Web: www.dolav.com